

經濟部國際貿易局

「形象館(區)設計圖——C款」

臺灣館造型設計施工說明手冊

C 款設計圖

設計主視覺元素:符合以下 3 個元素

1.長邊攤位主視覺:使用立體「Taiwan」。

TAIWAN

2.短邊攤位主視覺:使用立體「臺灣第一等一標誌」。



3.搭配具有代表性產業圖騰:依各展會之不同主題作置換。

字體應用

TAIWAN

Myriad Roman

ABCDEFGHIJKLMNOPQRSTUVWXYZ
abcdefghijklmnopqrstuvwxyz
0123456789

Myriad Bold

ABCDEFGHIJKLMNOPQRSTUVWXYZ
abcdefghijklmnopqrstuvwxyz
0123456789

LOGO應用建議



產業圖騰圖案建議參考

依各展會之不同主題作不同產業圖騰



能源／太陽光電類別展會



食品類別展會



五金零配件類別展會



汽車零配件類別展會



文創禮品類別展會



體育用品／紡織類別展會



木工機／工具機類別展會



電子資訊類別展會



美容化妝類別展會

示意參考圖



示意參考圖

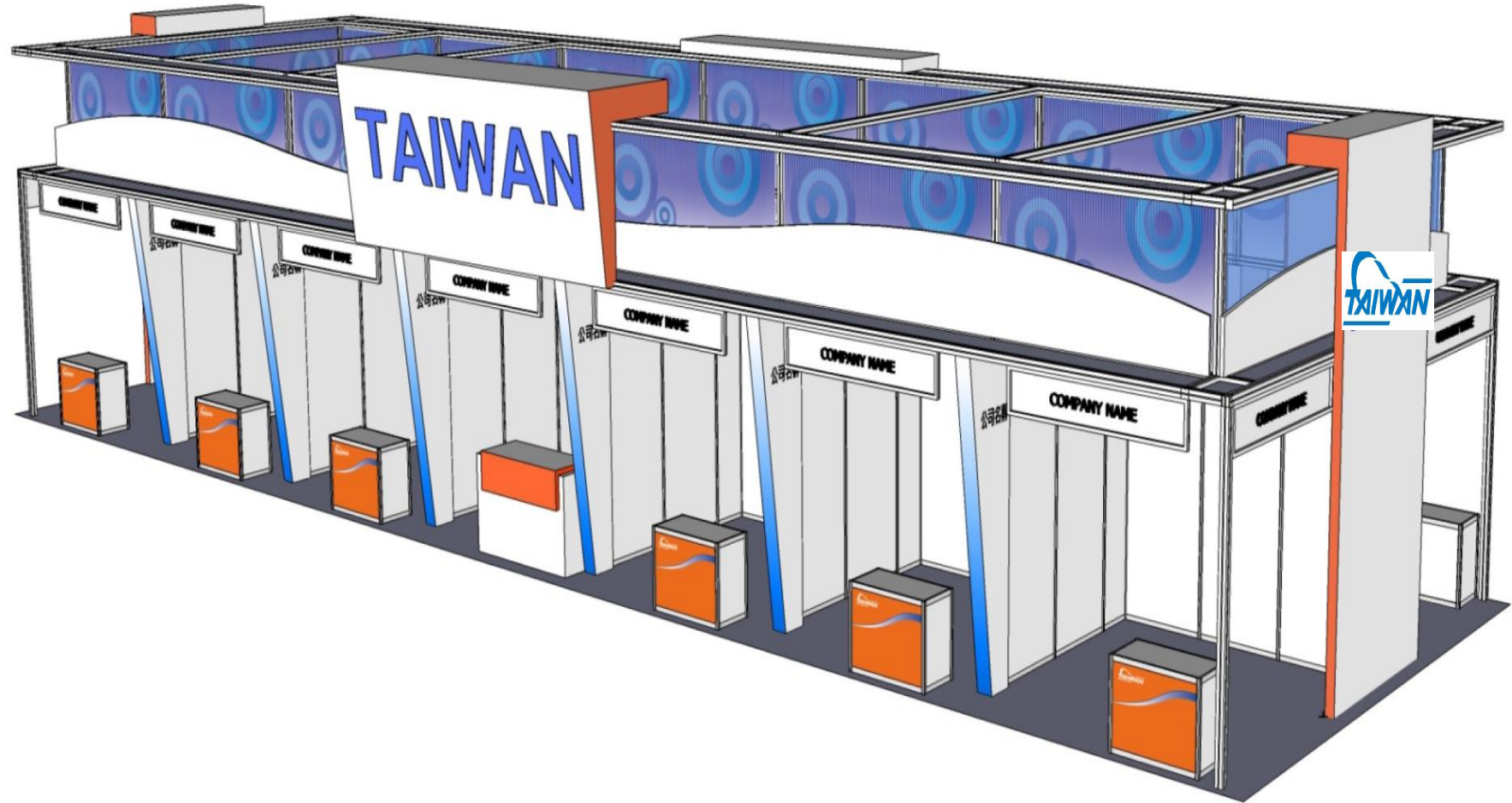

示意參考圖

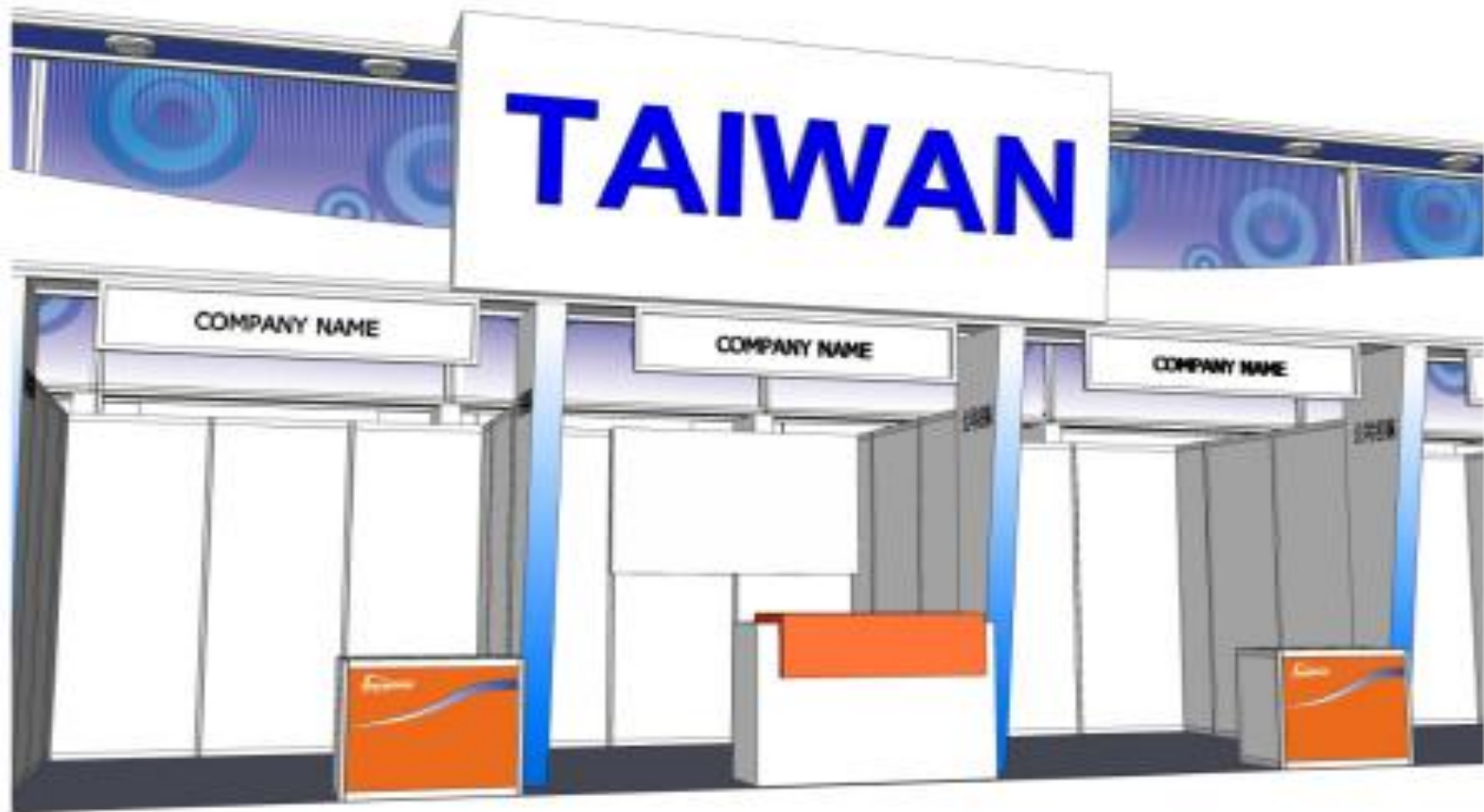

示意參考圖



施 工 圖

450cm/H 結構

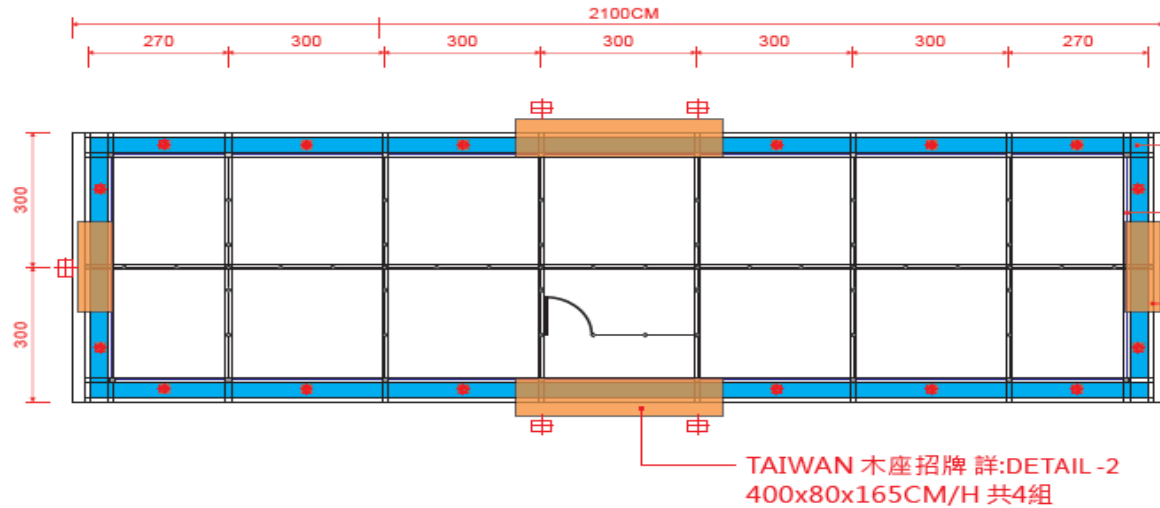

- 屋簷面貼輸出 50x5200CM PANTONE 312C
- 壓克力面貼透片輸出 300x150CM/H 共20組 250x150 CM/H 共16組
- TAIWAN 木座招牌 詳:DETAIL -3 200x80x480CM/H 共4組

TAIWAN 木座招牌 詳:DETAIL -2 400x80x165CM/H 共4組



300cm/H 結構

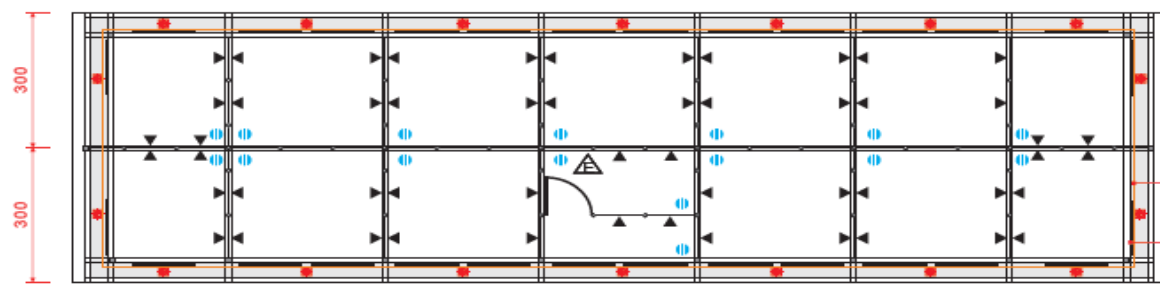

- 合成版面貼白色PVC
- 40W日光燈管(120CM) 2區共56組

①/3 FLOOR PLAN S:1/100

	壓克力接點透貼輸出150CM/高, W/GRAPHIC-1		220V/500W 攝燈		150W(白光)HQI 球燈		300W(白光)HQI球射燈
	合成版面貼白色PVC		100W投射燈		40W日光燈管(120CM)		

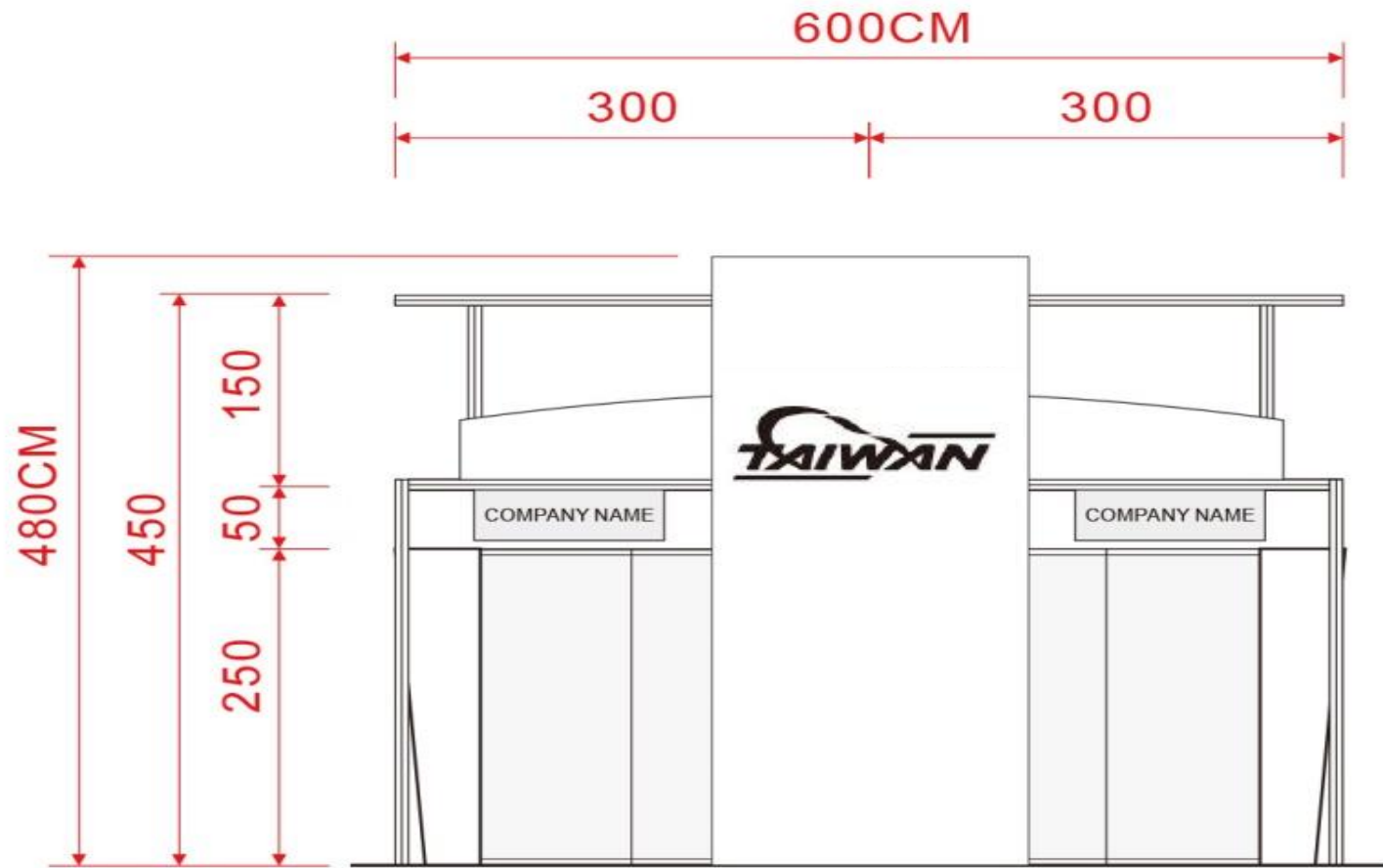

1
4

ELEVATION S:1/100

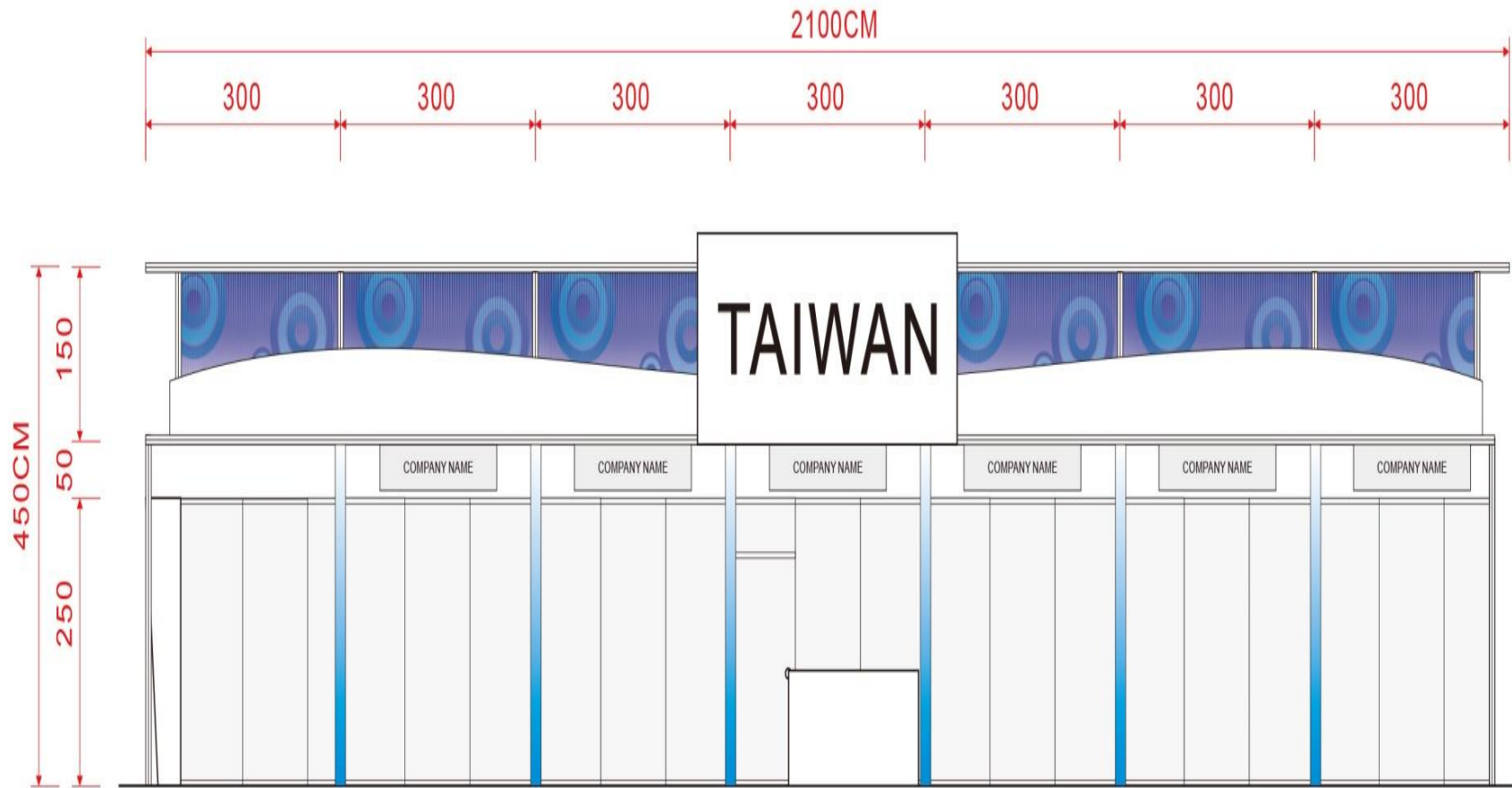

②
④ ELEVATION S:1/100

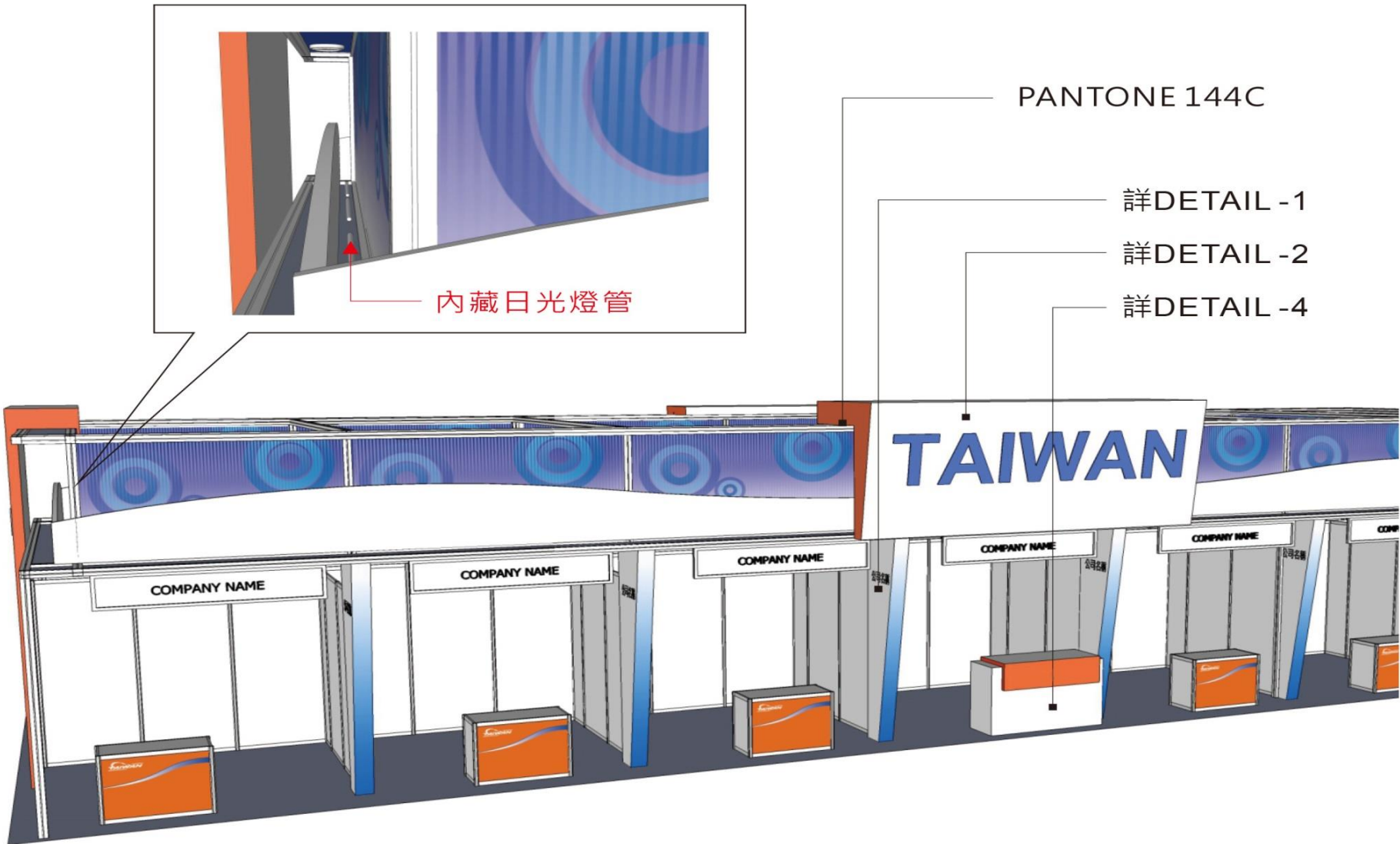

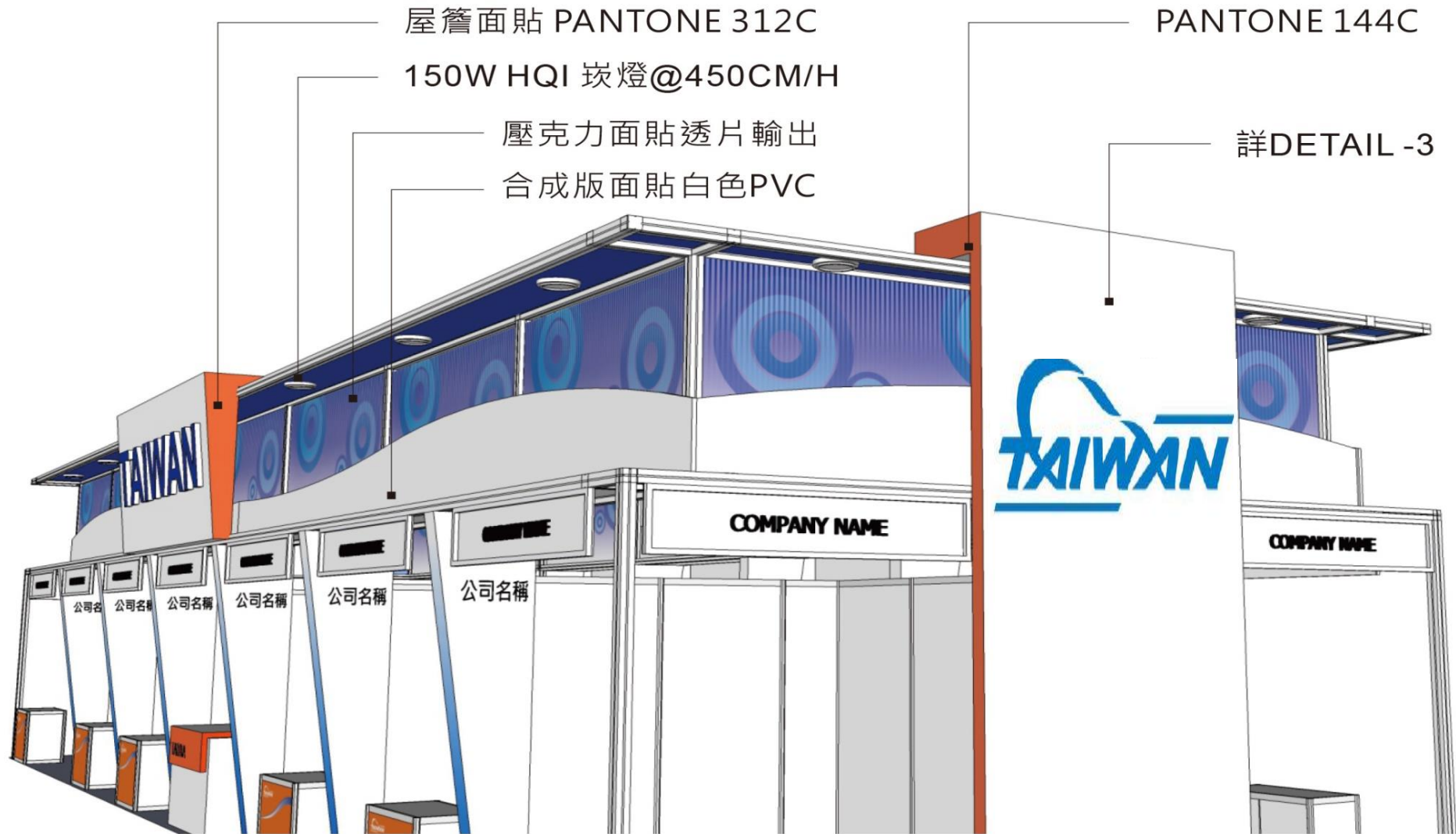

DETAIL -1

梯型木作壓克力燈箱 55x15x300CM/H
共24組

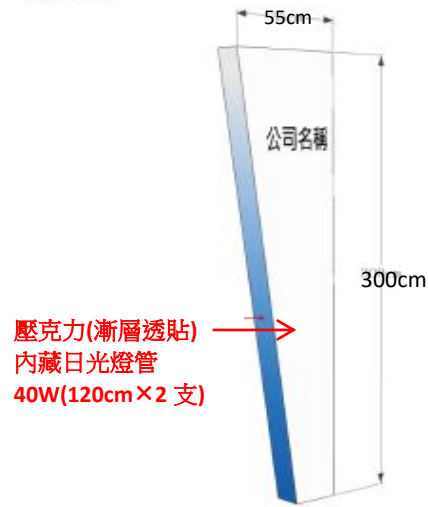

DETAIL -2

TAIWAN 木座招牌 400x80x165CM/H
共4組

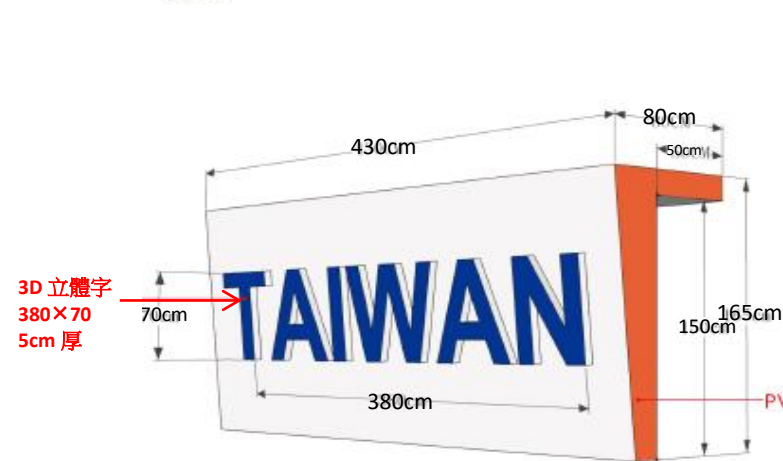

DETAIL -3

TAIWAN 木座招牌 350×80×480 C M/H
共4組

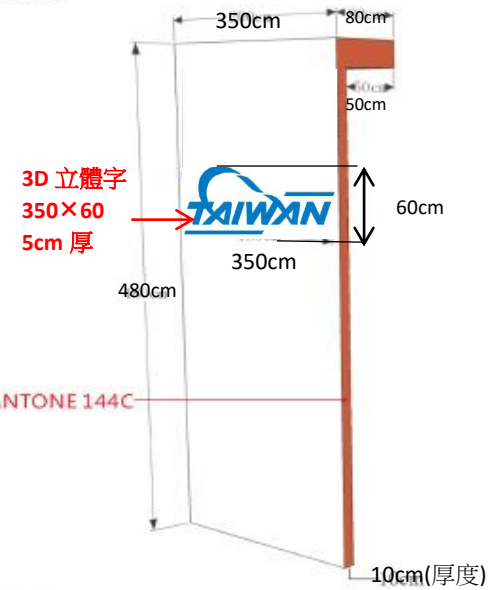

DETAIL -4

服務櫃台 100x53x103CM/H
PVC PANTONE 144C

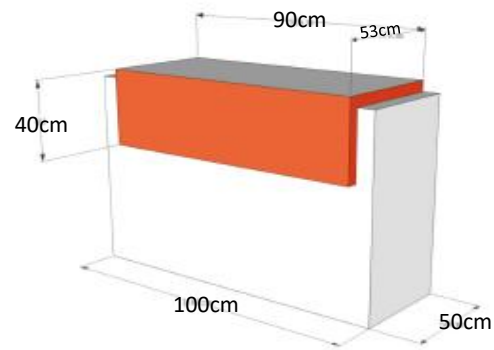
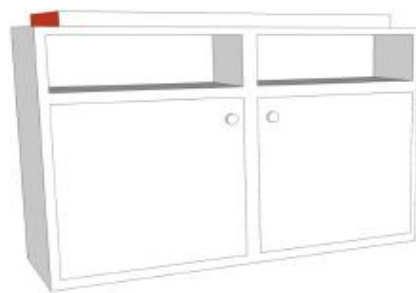

GRAPHIC-A

壓克力面貼透片輸出

